

STUDENTS' SPACE ASSOCIATION
THE FACULTY OF POWER AND AERONAUTICAL ENGINEERING
WARSAW UNIVERSITY OF TECHNOLOGY

PW-SAT2

PRELIMINARY REQUIREMENTS REVIEW

Communication

Phase A of PW-Sat2 project

1.0 EN

pw-sat.pl



2014-05-08

Abstract

The following document is a part of the summary of phase A of the student satellite project PW-Sat2. It describes the satellite's communication system, selected components, power balance and the proposed locations for the Ground Station.

The document is published as a part of:

PW-Sat2 – Preliminary Requirements Review

	PW-Sat2	Communication	
	1.0 EN	pw-sat.pl	
	Phase A of PW-Sat2 project		

REVISIONS

Version	Date	Changes	Responsible
		Polish version of the document.	Tomasz Rybarski
1.0 EN	2014-05-08	English version of the document	Tomasz Rybarski
1.0 EN	2014-05-08	Editing	Dominik Roszkowski
1.0.1 EN	2014-07-02	Small editorial changes	Dominik Roszkowski

This document is also available in Polish.



	PW-Sat2	Communication	
	1.0 EN	pw-sat.pl	
	Phase A of PW-Sat2 project		

TABLE OF CONTENTS

1 Introduction3

 1.1 Selected components.....3

 1.2 Technical parameters.....4

 1.3 Module block diagram5

2 Radio link power balance.....6

3 Ground station7

4 Reference8



LIST OF FIGURES

Figure 1-1 ISIS antenna module.....3

Figure 1-2 ISIS communications module.....4

LIST OF TABLES

Table 1-1 Technical parameters of transmitter and receiver4

	PW-Sat2	Communication	
	1.0 EN	pw-sat.pl	
	Phase A of PW-Sat2 project		

1 INTRODUCTION

1.1 SELECTED COMPONENTS

The VHF downlink and UHF uplink communications module is responsible for receiving commands, sending telemetry and payload data.

It has been decided to buy an existing communications module along with an antenna module. Modules designed by ISIS Space have been considered. The technical specification of the communications module [1] is obtained from the manufacturer's website. The antenna module is presented on the image [2] below:

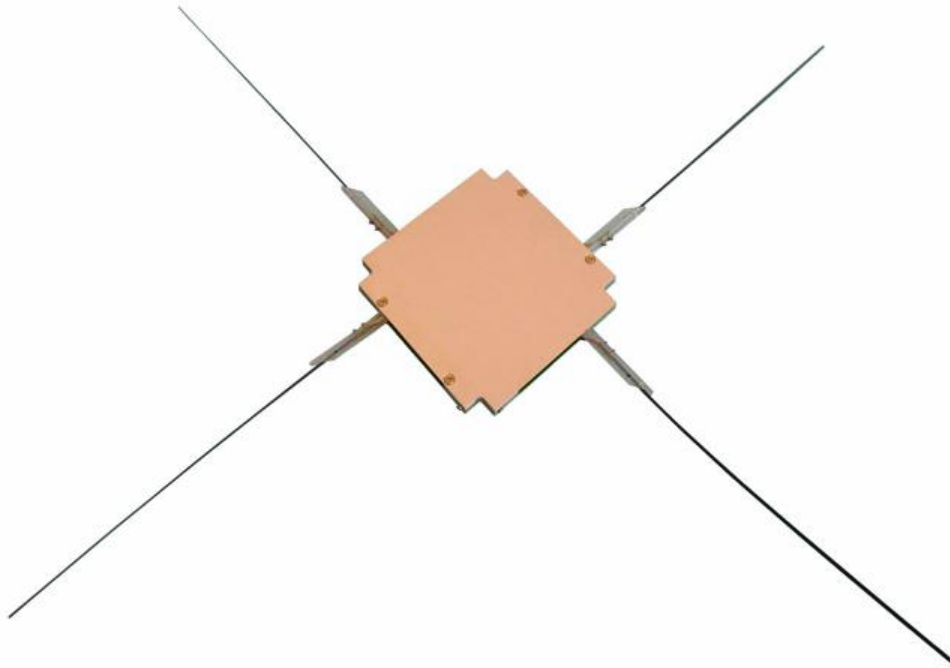

Figure 1-1 ISIS antenna module.

The transmission module (downlink) covers the VHF band (130-160 MHz frequency range), while the receiver (uplink) is designed to operate in the UHF band covering the frequencies 400 – 450 MHz.

The exact frequencies match these reserved for PW-Sat1 and are the following: 145.900 MHz (transmitter) and 435.020 MHz (receiver)

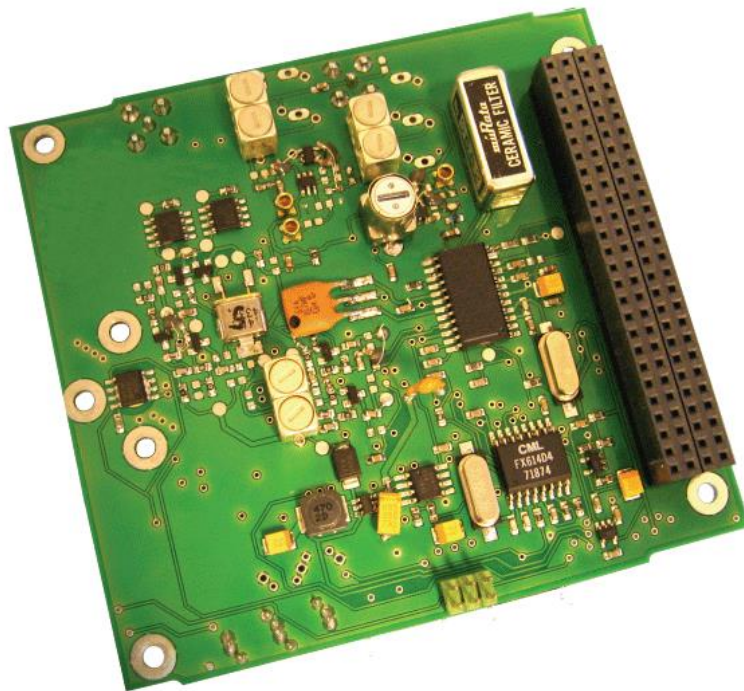

Figure 1-2 ISIS communications module.



1.2 TECHNICAL PARAMETERS

Transmitter parameters	
Power output	200 mW (22 dBm)
Data rate	9600 bps (max)
Modulation	BPSK
Receiver parameters	
Sensitivity	- 104 dBm
Bit Error Rate	10e-5
Modulation	AFSK
Power consumption	
Transmission mode	< 1.55 W
Receiving mode	< 0.2 W
Supply voltage	6.5 – 12.5 VDC

Table 1-1 Technical parameters of transmitter and receiver

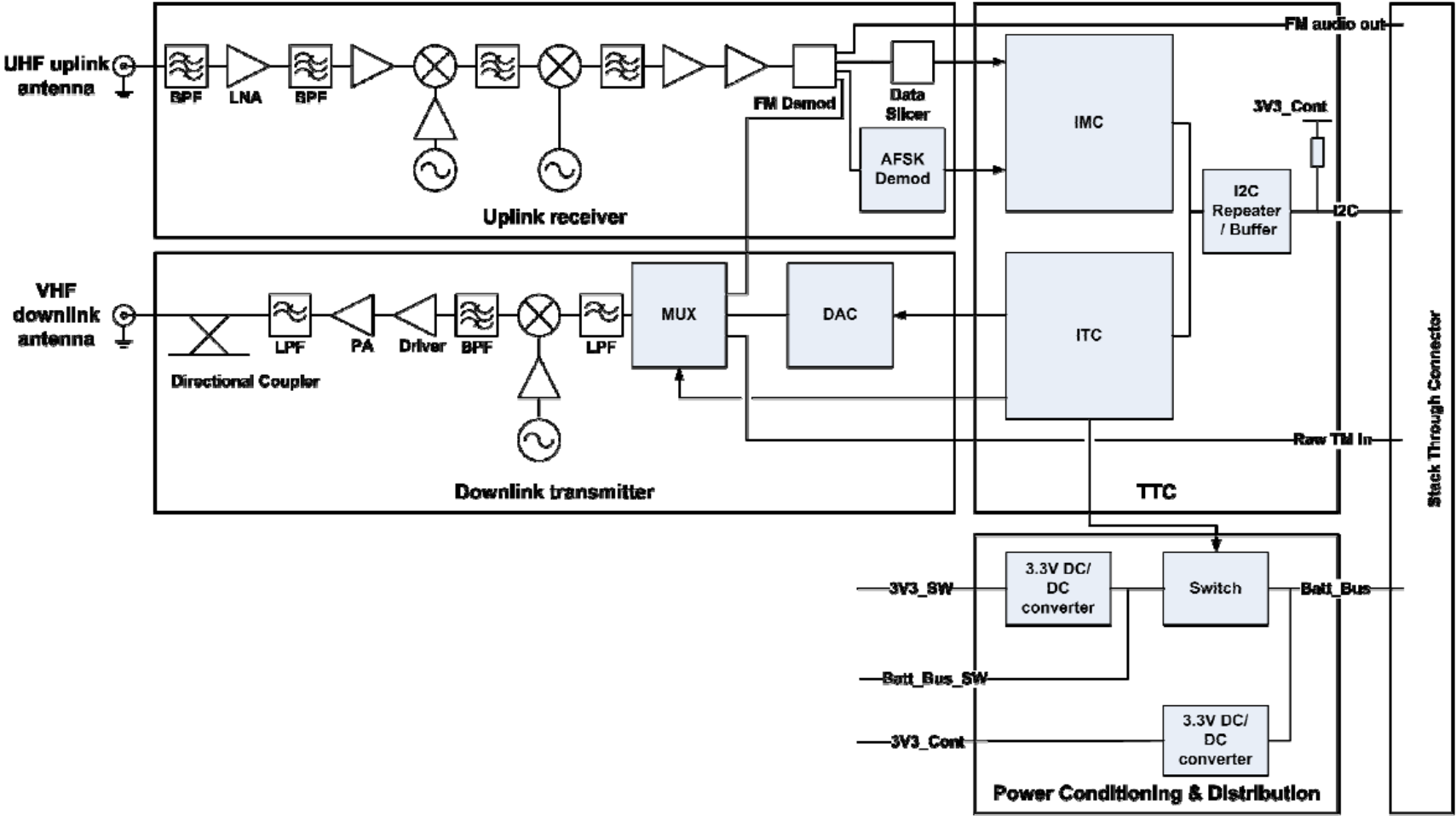
1.3 MODULE BLOCK DIAGRAM



	PW-Sat2	Communication	
	1.0 EN	pw-sat.pl	
	Phase A of PW-Sat2 project		

2 RADIO LINK POWER BALANCE

1. Attenuation of the transmitter – antenna path (feeder, connectors, etc.)

$$L_{\text{FTX}} = - 1.5 \text{ dB}$$

2. Attenuation in free space

$$L_{\text{FS}} = 32.45 + 20\log(f_{\text{[MHz]}}) + 20\log(d_{\text{[km]}})$$

The following assumptions were made:



- frequency 435.020 MHz (transmitter on Earth, receiver on board of the satellite)

- a) For the orbit of 600 km ($d = 600 \text{ km}$)

$$L_{\text{FS}} = 32.45 + 20\log(435.020) + 20\log(600) = 140.78 \text{ dB}$$

- b) For the orbit of 700 km ($d = 700 \text{ km}$)

$$L_{\text{FS}} = 32.45 + 20\log(435.020) + 20\log(700) = 142.12 \text{ dB}$$

	PW-Sat2	Communication	
	1.0 EN	pw-sat.pl	
	Phase A of PW-Sat2 project		



3 GROUND STATION

The GS team was also formed in Phase A. This team's responsibility was either building a new ground station or improving the existing one. . Finally the project of building a new station has been abandoned due to lack of funds and necessity. Cooperation has been established with already existing stations which have agreed on participating in communication with the satellite after launch.

Current Ground Stations taken into account:

1. Ground Station of the Faculty of Electronics and Information Technology, Warsaw University of Technology, Warsaw, Poland.
2. BRITE Ground Station, Nicolaus Copernicus Astronomical Center, Warsaw, Poland.
3. Ground Station of the ISIS company, Delft, Netherlands

Additionally it is considered to use this GENSO (*Global Educational Network for Satellite Operations*) network [3]. Unfortunately there is a risk associated with this solution since the network is not yet built.

	PW-Sat2	Communication	
	1.0 EN	pw-sat.pl	
	Phase A of PW-Sat2 project		

4 REFERENCE

- [1] ISIS - [http://www.cubesatshop.com/index.php?page=shop.product_details&flypage=flypage.t
pl&product_id=73&category_id=5&option=com_virtuemart&Itemid=67](http://www.cubesatshop.com/index.php?page=shop.product_details&flypage=flypage.tpl&product_id=73&category_id=5&option=com_virtuemart&Itemid=67)
- [2] ISIS - [http://www.cubesatshop.com/index.php?page=shop.product_details&flypage=flypage.t
pl&product_id=66&category_id=6&option=com_virtuemart&Itemid=70](http://www.cubesatshop.com/index.php?page=shop.product_details&flypage=flypage.t
pl&product_id=66&category_id=6&option=com_virtuemart&Itemid=70)
- [3] GENSO - http://www.esa.int/Education/How_GENSO_works