

STUDENTS' SPACE ASSOCIATION  
THE FACULTY OF POWER AND AERONAUTICAL ENGINEERING  
WARSAW UNIVERSITY OF TECHNOLOGY



## PRELIMINARY DESIGN REVIEW



---

### COMMUNICATION

Phase B of PW-Sat2 student satellite project

June 2015

Issue 2 (November 2016 update)

	PW-Sat2	Preliminary Design Review	
	2016-11-22	Communication	
	Phase B		

## Revisions

Date	Changes	Responsible
2015-01-18	Creation of this document.	Patryk Oleniuk
2015-04-24	Modification of GS information (chapter 3)	Kamil Sażyński
2015-05-29	Editorial changes	Dominik Roszkowski
2015-06-23	Chapter 4 update	Kamil Sażyński
2015-08-11	Editorial changes in the bibliography Merged with separate issue	Dominik Roszkowski
2016-11-22	New template and disclaimer	Dominik Roszkowski

**Attention** Phase B documentation may be outdated in many points. Please be aware of that and do not depend on Phase B or Phase A documents only. More recent documentation is available on project website.

---

Published by

Students' Space Association

Warsaw University of Technology, 2015



This work is licensed on CC BY-NC 3.0

Project logo by Krzysztof Karaś

Artist's impressions by Marcin Świetlik



Quote as: PW-Sat2 Team, *Phase B Documentation – Preliminary Design Review – Communication (Issue 2)*,

Students' Space Association, Warsaw University of Technology, pw-sat.pl 2015

	PW-Sat2	Preliminary Design Review	
	2016-11-22	Communication	
	Phase B		

## Table of contents

<b>1</b>	<b>Communication module overview</b>	<b>5</b>
1.1	Basic Parameters .....	5
1.2	Module block diagram .....	7
1.3	Input/Output Interfaces .....	7
<b>2</b>	<b>Antenna Module overview</b>	<b>8</b>
2.1	Transmitter/receiver antenna configuration .....	9
<b>3</b>	<b>Ground station overview</b>	<b>10</b>
3.1	Main ground station in Warsaw .....	10
3.1.1	<i>Equipement</i> .....	10
3.2	Expected parameters .....	10
<b>4</b>	<b>Radio link power budget</b>	<b>11</b>
4.1	Uplink .....	13
4.2	Downlink.....	14
<b>5</b>	<b>Communication scenarios and data format</b>	<b>15</b>
<b>6</b>	<b>Testing</b>	<b>16</b>
6.1	Transmitter module tests .....	16
6.2	Receiver module tests .....	16
6.3	Antenna module tests .....	17
<b>7</b>	<b>Bibliography</b>	<b>18</b>

	PW-Sat2	Preliminary Design Review	
	2016-11-22	Communication	
	Phase B		

## List of figures

Figure 1-1 Photo of ISIS UHF downlink / VHF uplink Full Duplex Transceiver PCB.	5
Figure 1-2 Functional block diagram of of ISIS UHF downlink / VHF uplink Full Duplex Transceiver.	7
Figure 2-1 ISIS Deployable Antenna System.	8
Figure 2-2 ISIS Deployable Antenna System configuration.	9
Figure 6-1 Measurement schematic for transmitter tests.	16
Figure 6-2 Measurement schematic for receiver tests.	17

## List of tables

Table 1-1 Parameters of ISIS UHF downlink / VHF uplink Full Duplex Transceiver.	5
Table 2-1 Parameters of deployment system.	9
Table 3-1 Worst-case GS parameters	10
Table 4-1 Budget link parameters	11
Table 4-2 Calculated parameters for signal receiving by satellite	13
Table 4-3 Calculated parameters for signal receiving by Ground Station	14

	PW-Sat2	Preliminary Design Review	
	2016-11-22	Communication	
	Phase B		

## Abbreviated terms

ADCS – Attitude Determination and Control System

CAM - Cameras

COMM – Communication System

EPS – Electrical Power System

DT – Deployment Team

MA – Mission Analysis

OBC – On-board Computer



SunS – Sun Sensor

SKA – Students' Space Association (Studenckie Koło Astronautyczne)

TCS – Thermal Control System

BER – Bit Error Rate

RF – Radio Frequency

	PW-Sat2	Preliminary Design Review	
	2016-11-22	Communication	
	Phase B		

# 1 COMMUNICATION MODULE OVERVIEW

**Attention** Phase B documentation may be outdated in many places. Please be aware of that and do not depend on Phase B or Phase A documents only. More recent documentation is available on project website.

The UHF downlink and VHF uplink communications module is responsible for receiving commands, sending telemetry and payload data. It has been decided to buy an existing communications module along with an antenna module. ISIS UHF downlink / VHF uplink Full Duplex Transceiver have been chosen. The technical specification of the communications module is obtained from the manufacturer’s website [1]. The antenna module is presented on the image below:

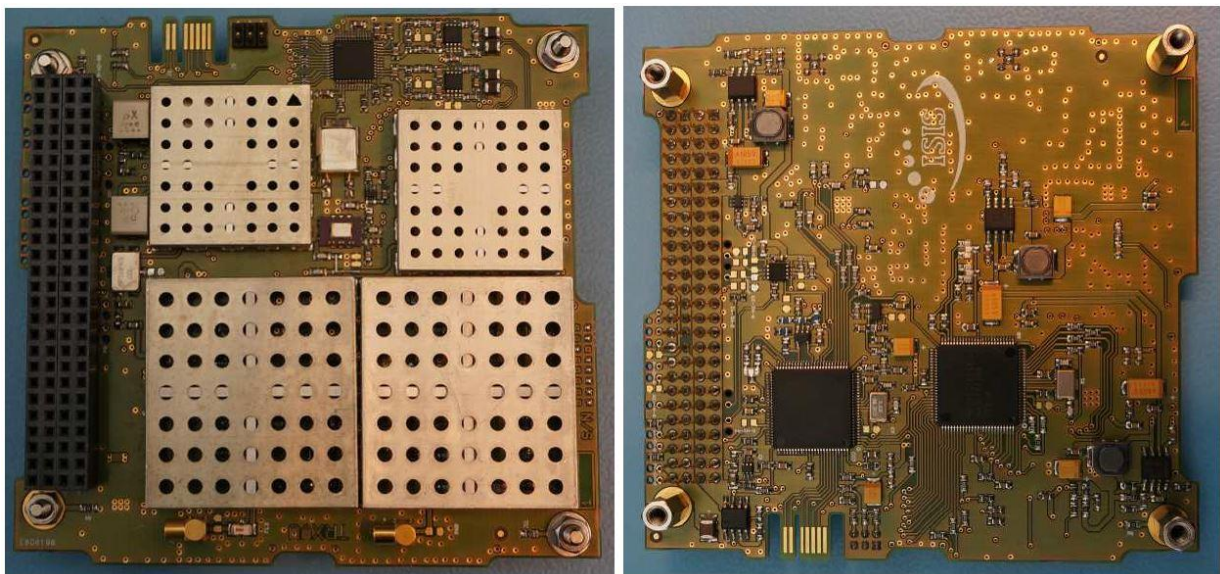



Figure 1-1 Photo of ISIS UHF downlink / VHF uplink Full Duplex Transceiver PCB.

## 1.1 BASIC PARAMETERS

Most important parameters of chosen communication module is shown in Table 1-1 from [1].

Table 1-1 Parameters of ISIS UHF downlink / VHF uplink Full Duplex Transceiver.

Technical parameters of an UHF transmitter	
RF output power	500 mW (27 dBm)

	PW-Sat2	Preliminary Design Review	
	2016-11-22	Communication	
	Phase B		



Bitrate	9600 bps (max)
Modulation type	BPSK
Link layer protocol	AX.25
Technical parameters of a VHF receiver	
Sensitivity	- 105 dBm
Data rate	1200 bit/s
BER (Bit Error Rate)	10e-5
Modulation type	AFSK
Link layer protocol	On-board AX.25 command decoding
Frequency deviation	3kHz
Power consumption	
Supply voltage	6.5 – 12.5 VDC
While transmitting and receiving ( $V_{sup} = 7V$ )	Max. 2170mW
While receiving ( $V_{sup} = 7V$ )	Max. 455mW

The module will be prepared to transmit/receive on frequencies from PW-SAT1 satellite:

145.900 MHz (VHF Uplink)

435.020 MHz (UHF Downlink)

**Uplink and downlink frequencies was swapped regarding phase A documentation. This action was performed due to known RF interferences with military radar bands in Poland.**

	PW-Sat2	Preliminary Design Review	
	2016-11-22	Communication	
	Phase B		

## 1.2 MODULE BLOCK DIAGRAM

Transceiver can be divided into 3 basic parts: receiver, transmitter, and data processing block. Both receiver and transmitter are basic heterodyne devices and their frequencies will be configured by ISIS. Shared data processing block is responsible for processing input/output data so that it'll be ready to write/read from I2C. Block diagram of the module is shown below.

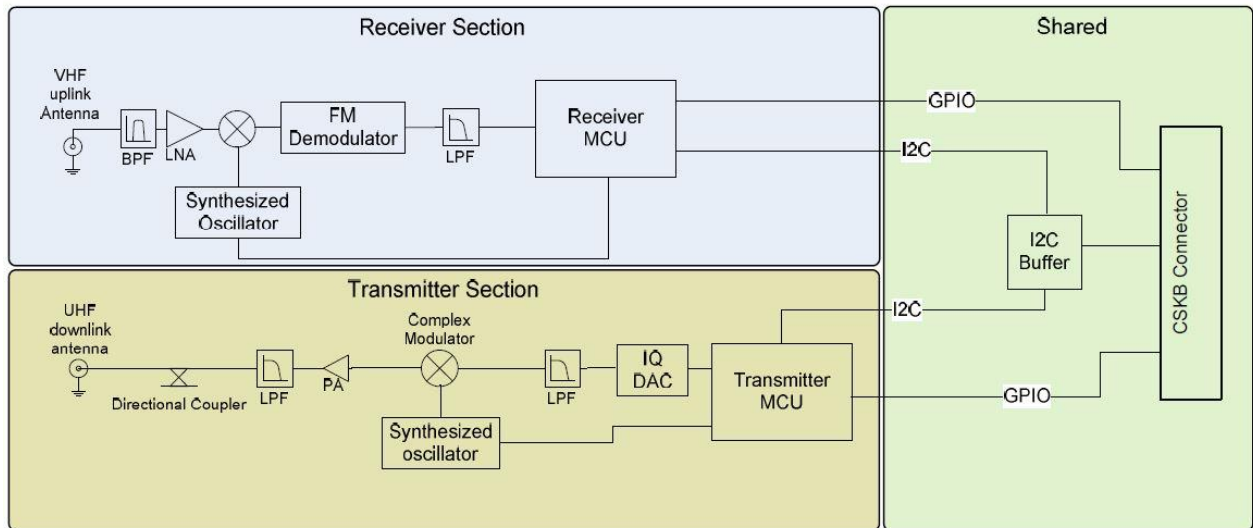

**Figure 1-2 Functional block diagram of of ISIS UHF downlink / VHF uplink Full Duplex Transceiver.**



## 1.3 INPUT/OUTPUT INTERFACES

The module will be connected to PC-104 stack connector on appropriate pins handling I2C, power supply and additional features described in [2]. Configuration of device electronics and calibration with the antennas is made by ISIS.

Communication module is designed to communicate with OBC or EPS (in emergency mode) via I2C.

The module will be connected to antennas via MMCX connectors. Impedance of connectors and lines is 50  $\Omega$ . Cables with proper length and properties will be used.



	PW-Sat2	Preliminary Design Review	
	2016-11-22	Communication	
	Phase B		

## 2 ANTENNA MODULE OVERVIEW

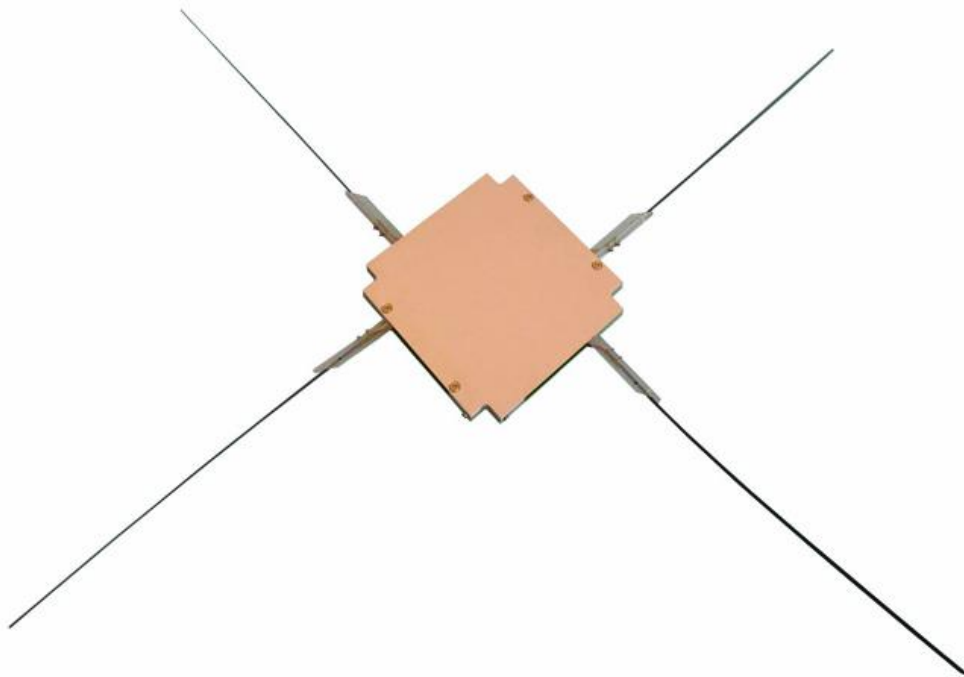

---

Transceiver will be connected to suitable antenna system from ISIS. Due to the fact, that for selected frequencies antennas length exceed satellite dimensions, deployable antenna system was chosen.



**Figure 2-1 ISIS Deployable Antenna System.**

Deployment of antenna module is implemented using special wires that are burned out by DC current in few seconds and release deployment mechanism. The whole antenna deployment system is one of critical ones, so its sub-systems are duplicated – including communication lines and burn-out wires. According to this, it has two addresses and if there's no confirmation after first try of revealing the antennas, there's a possibility of connecting to the module via another address. Some basic parameters of Antenna module is show on Table 2-1.

	PW-Sat2	Preliminary Design Review	
	2016-11-22	Communication	
	Phase B		

**Table 2-1 Parameters of deployment system.**

Antenna module configuration	
Bus	I2C Dual Bus
Primary/secondary I2C address	0x31 / 0x32
Connectors type	MMCX
Supply voltage	5 VDC
Antenna gain	2.15dBi

## 2.1 TRANSMITTER/RECEIVER ANTENNA CONFIGURATION

Selected mechanical configuration for antennas is shown on Figure 2-2.

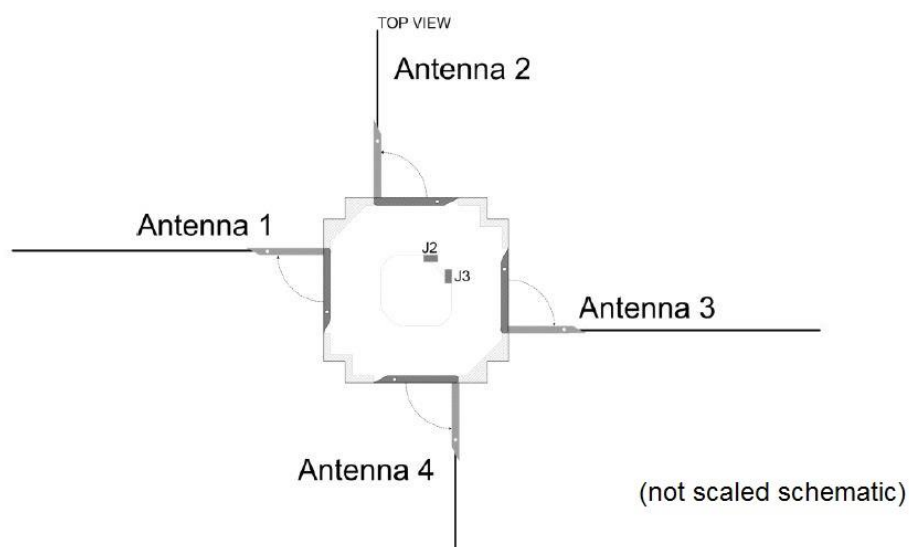

Dipole Configuration

Dipole A (Antenna 1 + 3)

Dipole B (Antenna 2 + 4)



VHF -

145,900

UHF -

435,020

**Figure 2-2 ISIS Deployable Antenna System configuration.**

	PW-Sat2	Preliminary Design Review	
	2016-11-22	Communication	
	Phase B		

## 3 GROUND STATION OVERVIEW

---

The GS team was formed in Phase A. This teams responsibility was either building a new ground station or improving the existing one. Cooperation has been established with already existing stations which have agreed on participating in communication with the satellite after launch.

### 3.1 MAIN GROUND STATION IN WARSAW

Main base station that will be used to communicate with PW-Sat2 will be placed in the Faculty of Electronics and Information Technology, ul. Nowowiejska 15/19, 00-665 Warszawa.

#### 3.1.1 EQUIPEMENT



The station is equipped with transceiver ICOM IC-910H, computer, system to rotation antennas and TNC to digis modes. Using the experience of BRITE team, we decided to use antennas with circular polarization – Tonna 20818 for VHF and Tonna 20938 for UHF. Antennas will be used with symmetrical splitters. This will eliminate a decrease in the radio signal associated with the rotating PW-Sat2.

### 3.2 EXPECTED PARAMETERS

It is expected, that every one of GS mentioned above has parameters equal or better than mentioned in [1].

**Table 3-1 Worst-case GS parameters**

Name	Value	[Unit]
Frequency (Receiver / Transmitter)	435.020 / 145.900	[MHz]
Radio link length $l$ (depends on orbit)	500 - 1000	[km]
Transmitter antenna gain	14,8	[dBi]
Additional losses	20	[dB]
Gain to noise temperature	7	[dB/K]
Transmitter RF power suppliance	50	[dBm]
Bandwidth	10	[kHz]

	PW-Sat2	Preliminary Design Review	
	2016-11-22	Communication	
	Phase B		

## 4 RADIO LINK POWER BUDGET

---

In order to validate the communication will be carried out comparing the received power and receiver sensitivity. For this will be used the following formulas:

Receiver sensitivity:

$$RX[dBW] = 10 * \log\left(\frac{RXU[V]^2}{Z[\Omega]}\right)$$

Noise power in receiver:

$$NRX[dBW] = RXS[dBW] - SINAD[dB]$$

Noise temperature in receiver:

$$T [dB] = NRX[dBw] - K[dB] - B[dB]$$

Free space losses:

$$FSL [dB] = 32,44 + 20 \log r [km] + 20 \log f [MHz]$$

Power of signal in receive system:

$$C[dBw] = TXP[dBw] + TXAG[dB] + RXAG[dB] - LFRX[dB] - LA[dB] - LP[dB] - LM[dB] - FSL[dB]$$



Signal to noise:

$$CNR[dB] = C[dBW] - NRX[dBW]$$



The table below shows the values used in the calculations.

**Table 4-1 Budget link parameters**

Description	Symbol	Value	Unit	Value [dB]
Minimal distance	dmin	800	km	
Maximal distance	dmax	2400	km	
Frequency UP-link	fup	435,02	MHz	
Frequency DOWN-link	fdown	145,9	MHz	

	PW-Sat2	Preliminary Design Review	
	2016-11-22	Communication	
	Phase B		

Satellite transmitter RF power	TXP			-3
Satellite antenna gain	AG			2,15
GS TX antenna gain	TXAG			13,1
GS RX antenna gain	RXAG			16
Temperature of GS antenna	TA0g	290	K	
Temperature of satellite antenna	TA0s	310	K	
Boltzman const.	K			-228,6
Impedance	Z	50	Ohm	
Channel width	B	15	kHz	41,8
DOWN-link speed	BRd	1200/9600	bps	30,8
UP-link speed	Bru	1200	bps	30,8
SINAD				12
GS receiver sensitivity	RXUg	0,18	uV	<b>-151,88425</b>
Satellite receiver sensitivity	RXUs			<b>-135</b>
Atmosphere losses	LA			0,1
Loss of polarization	LP			3
Free Space Losses (max UP)	FSLmaxU			152,811777
Free Space Losses (min UP)	FSLminU			143,2693519
Free Space Losses (max DOWN)	FSLmaxD			143,3226984
Free Space Losses (min DOWN)	FSLminD			133,7802733
Margin	LM			6
GS transmitter RF power	PGS	100	W	20
Temperature of space noise	TA0	100	K	
Temperature	TF	290	K	
Antenna cable length	DC	30	m	
Losses in 100m antenna cable	LF100			9
Losses in antenna cable	LFRX	1,86208714	W/W	2,7

	PW-Sat2	Preliminary Design Review	
	2016-11-22	Communication	
	Phase B		

## 4.1 UPLINK

Using the above formulas and values, calculated parameters of the radio link. Below presents parameters received by satellite COMM module. It is the parameters of uplink communications:



**Table 4-2 Calculated parameters for signal receiving by satellite**

Description		Value	Unit	Value [dB]
Noise temperature of receiver	TR	9549,92586	K	39,8
Temperature of receiver antenna	TAS	100	K	20
Noise temperature of receiving system	TU	9649,92586	K	39,84523977
Received power (for FSLmax)	Cmin			<b>-126,661777</b>
Received power (for FSLmin)	Cmax			<b>-117,119352</b>
Power of noise in receiver	NRX			-146,95476
SNR (for Cmin)	CNR			20,29298322
SNR (for Cmax)	CNR			29,83540832

Use of the above formulas are calculated the worst case:

Received power	PR [dBW]	<b>- 126,6 dB</b>
Sensitivity of PW-Sat2 receiver	RXUs [dBW]	<b>-135 dB</b>

The value of the received power is greater than the sensitivity, it means that communication will be provided. Also Signal to Noise is sufficient: **20,3dB**.

	PW-Sat2	Preliminary Design Review	
	2016-11-22	Communication	
	Phase B		

## 4.2 DOWNLINK

Using the above formulas and values, calculated parameters of the radio link. Below presents parameters received by ground station system. It is the parameters of downlink communications:



**Table 4-3 Calculated parameters for signal receiving by Ground Station**

Description		Value	Unit	Value [dB]
Noise temperature of receiver	TR	195,6928715	K	22,91575006
Temperature of receiver antenna	TAS	187,9639587	K	22,74074583
Noise temperature of receiving system	TU	383,6568302	K	25,83942934
Received power (for FSLmax)	Cmin			<b>-139,872698</b>
Received power (for FSLmin)	Cmax			<b>-130,330273</b>
Power of noise in receiver	NRX			-160,960571
SNR (for Cmin)	CNR			21,08787229
SNR (for Cmax)	CNR			30,63029739

Use of the above formulas are calculated the worst case:

Received power	PR [dBW]	<b>- 139,9 dB</b>
Sensitivity of GS receiver	RXUg [dBW]	<b>-152 dB</b>

The value of the received power is greater than the sensitivity, it means that communication will be provided. Also Signal to Noise is sufficient: **21dB**.

	PW-Sat2	Preliminary Design Review	
	2016-11-22	Communication	
	Phase B		

## 5 COMMUNICATION SCENARIOS AND DATA FORMAT

---

Selected communication system is using AX.25 data link layer protocol designed for use by amateur radio operators. It is used extensively on amateur packet radio networks.



To transmit satellite-specific information, additional data structures will be designed. This data bytes structures are automatically put into AX.25 frames.

Each information is transmitted repeatedly for a number of times. This number depends on:

- tests performed on communication system described in section 6. of this document
- communication timetable analysis from MA team.
- transmitted message size

Except telemetry messages, after a message(e.g. image) is received properly in satellite/GS receiver, confirmation flag is send, so that transmitter can transmit next messages or turn off. Control scenarios and structure depends on OBC module.



	PW-Sat2	Preliminary Design Review	
	2016-11-22	Communication	
	Phase B		

## 6 TESTING

When the module will be available from ISIS, the following tests will be performed.

### 6.1 TRANSMITTER MODULE TESTS

For testing transmitter functionality schematic from Figure 6-1 Measurement schematic for transmitter tests. is going to be used.

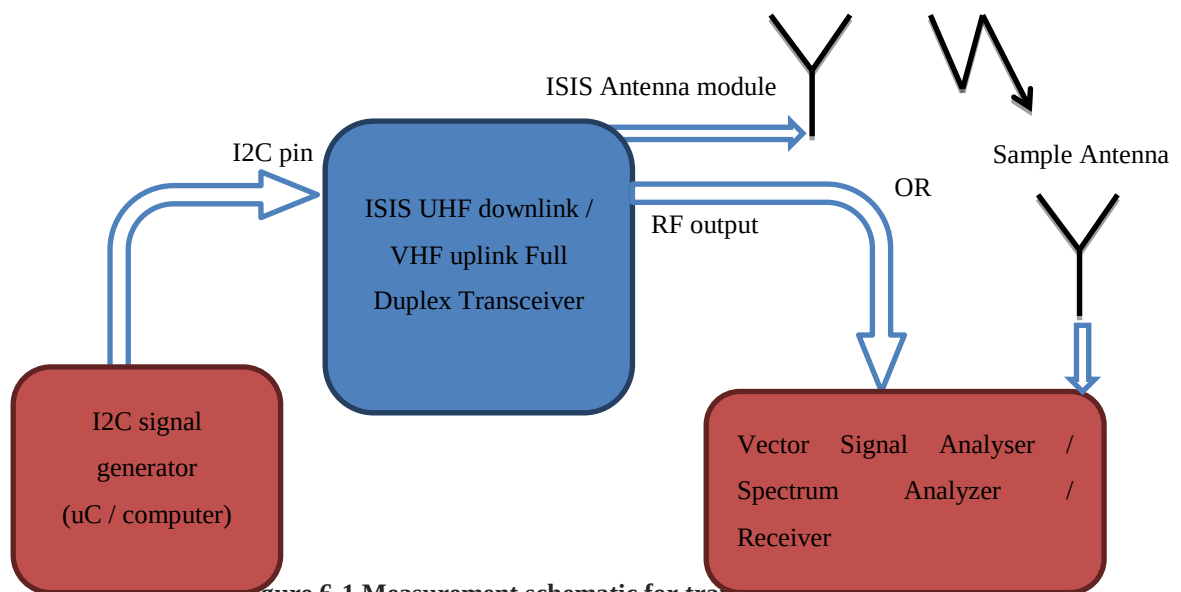



Figure 6-1 Measurement schematic for transmitter tests.

### 6.2 RECEIVER MODULE TESTS

	PW-Sat2	Preliminary Design Review	
	2016-11-22	Communication	
	Phase B		

For testing receiver functionality schematic from Figure 6-1 Measurement schematic for transmitter tests. is going to be used.

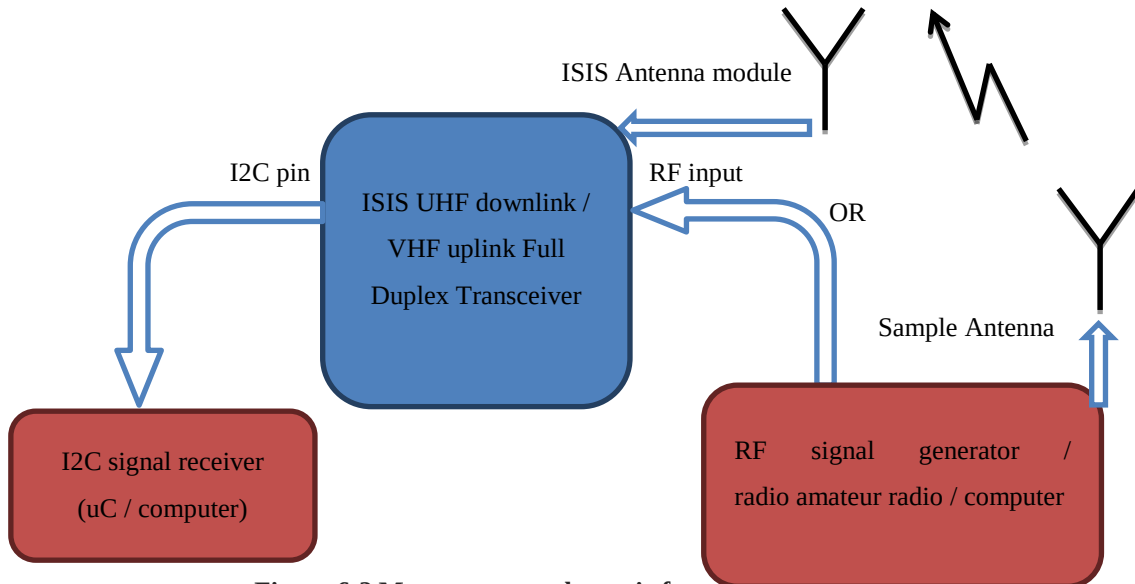



Figure 6-2 Measurement schematic for receiver tests.

### 6.3 ANTENNA MODULE TESTS

The main purpose of measuring antennas is to experimentally find, if satellite structure affects its directivity. Antenna directivity will be measured with the following configurations:

- Only antenna module
- Antenna module with PW-Sat2 satellite model
- With photovoltaic wings closed, deorbit sail closed
- With photovoltaic wings opened, deorbit sail closed
- With photovoltaic wings opened, deorbit sail opened



Depending on accessibility of an anechoic chamber, the measurement will be performed with selected accuracy and method.

	PW-Sat2	Preliminary Design Review	
	2016-11-22	Communication	
	Phase B		

## 7 BIBLIOGRAPHY

---

- [1] ISIS Space, "ISIS UHF downlink / VHF uplink Full Duplex Transceiver," [Online]. Available: [http://www.cubesatshop.com/index.php?page=shop.product\\_details&flypage=flypage.tpl&product\\_id=11&category\\_id=5&option=com\\_virtuemart&Itemid=67](http://www.cubesatshop.com/index.php?page=shop.product_details&flypage=flypage.tpl&product_id=11&category_id=5&option=com_virtuemart&Itemid=67).
- [2] ISIS, "ICD for the TRXVU - Documentation."
- [3] K. Kurek, Materiały do przedmiotu "Łączność Satelitarna" na wydz. EiTI PW, 2014.
- [4] "Tabela przeznaczeń częstotliwości UKE".
- [5] B. Sklar, Digital Communications: Fundamentals and Applications, 2001.
- [6] J. Cichocki, Materiały do przedmiotu "Miernictwo Radioelektroniczne" na wydz. EiTI PW, 2014.
- [7] "Dokumentacja płytki Altera DE0," [Online]. Available: [http://www.ee.ic.ac.uk/pcheung/teaching/ee2\\_digital/DE0\\_User\\_manual.pdf](http://www.ee.ic.ac.uk/pcheung/teaching/ee2_digital/DE0_User_manual.pdf).
- [8] "Dokumentacja układu C/A AD5340," [Online]. Available: [http://www.analog.com/static/imported-files/data\\_sheets/AD5330\\_5331\\_5340\\_5341.pdf](http://www.analog.com/static/imported-files/data_sheets/AD5330_5331_5340_5341.pdf).
- [9] "Dokumentacja układu RFMD2081," [Online]. Available: <http://www.farnell.com/datasheets/1699519.pdf>.
- [10] "Dokumentacja wzmacniacza operacyjnego AD8544R," [Online]. Available: [http://www.analog.com/static/imported-files/data\\_sheets/AD8541\\_8542\\_8544.pdf](http://www.analog.com/static/imported-files/data_sheets/AD8541_8542_8544.pdf).
- [11] "Instrukcja programowania układu RFMD2081," [Online]. Available: [http://www.rfmd.com/store/downloads/dl/file/id/28720/eval\\_board\\_and\\_programming\\_tool\\_guide\\_for\\_mixers\\_and\\_modulators\\_with\\_integrated\\_synthesizers.pdf](http://www.rfmd.com/store/downloads/dl/file/id/28720/eval_board_and_programming_tool_guide_for_mixers_and_modulators_with_integrated_synthesizers.pdf).

	PW-Sat2	Preliminary Design Review	
	2016-11-22	Communication	
	Phase B		

[12] Altera, “PowerPlay Early Power Estimator Download for Cyclone III Devices,” [Online]. Available: <http://www.altera.com/support/devices/estimator/pow-powerplay.jsp>.

[13] “Dokument opisujący anteny ISIS,” [Online]. Available: [http://www.cubesatshop.com/index.php?page=shop.product\\_details&flypage=flypage.tpl&product\\_id=66&category\\_id=6&option=com\\_virtuemart&Itemid=70](http://www.cubesatshop.com/index.php?page=shop.product_details&flypage=flypage.tpl&product_id=66&category_id=6&option=com_virtuemart&Itemid=70).